

Tips & Tricks

Folded pamphlets

[Folded pamphlets](#) | [Half-fold](#) | [Trifold](#) | [Z-fold](#) | [Folding Guidelines](#)

Folded pamphlets

Choosing the right fold for your pamphlet is a lot like riding a bicycle, the first few times it's a little tricky but with a little practice you get the hang of it and you're ready to go. When trying to decide what type of fold you want for your pamphlet or brochure, it's usually a good idea to think about what kind of content will go inside, who your target audience is and how they will be used.

Like a pair of stabilisers (or training wheels), we have prepared some information to assist you when you put together your folded pamphlet designs. You'll read about the different types of folds, how they differ and their size specs.

Half-fold or bi-fold

The simplest of the fold types which goes by many names. It has a single fold that divides the paper into two equal parts, resulting in 4 same width panels (2 on the front, 2 on the back). When used with flyer stock papers, [half-fold pamphlets](#) are perfect for marketing sales or event promotions. With thicker card stock papers, it can be used to create double size business cards, point cards or greeting cards.

Outside

TOP

Inside

TOP

After Folding



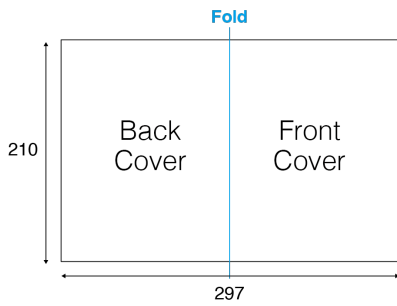

BOTTOM

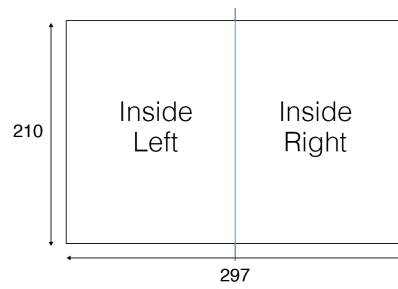

BOTTOM

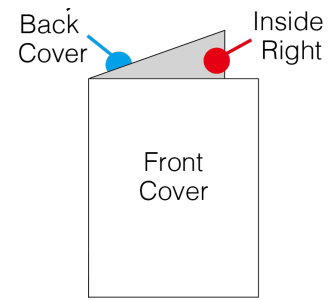

Trifold, or letter fold

A trifold is a type of fold that uses two parallel folds to create six panels on a sheet (3 panels per side). Two of the panels have the same width, but the innermost folding panel is 3mm less wide than the outer two. This panel that folds in the inside needs to be less wide to prevent the paper from buckling when the pamphlet is closed.

The [trifold pamphlet](#) offers six panels to organise information into the different panels. They are really popular because you can tell your story visually through the panels, guiding a prospective customer through your presentation. Trifolds are commonly used for marketing events, mailing campaigns, product or sales promotional materials, or compact company profiles.

Outside

TOP

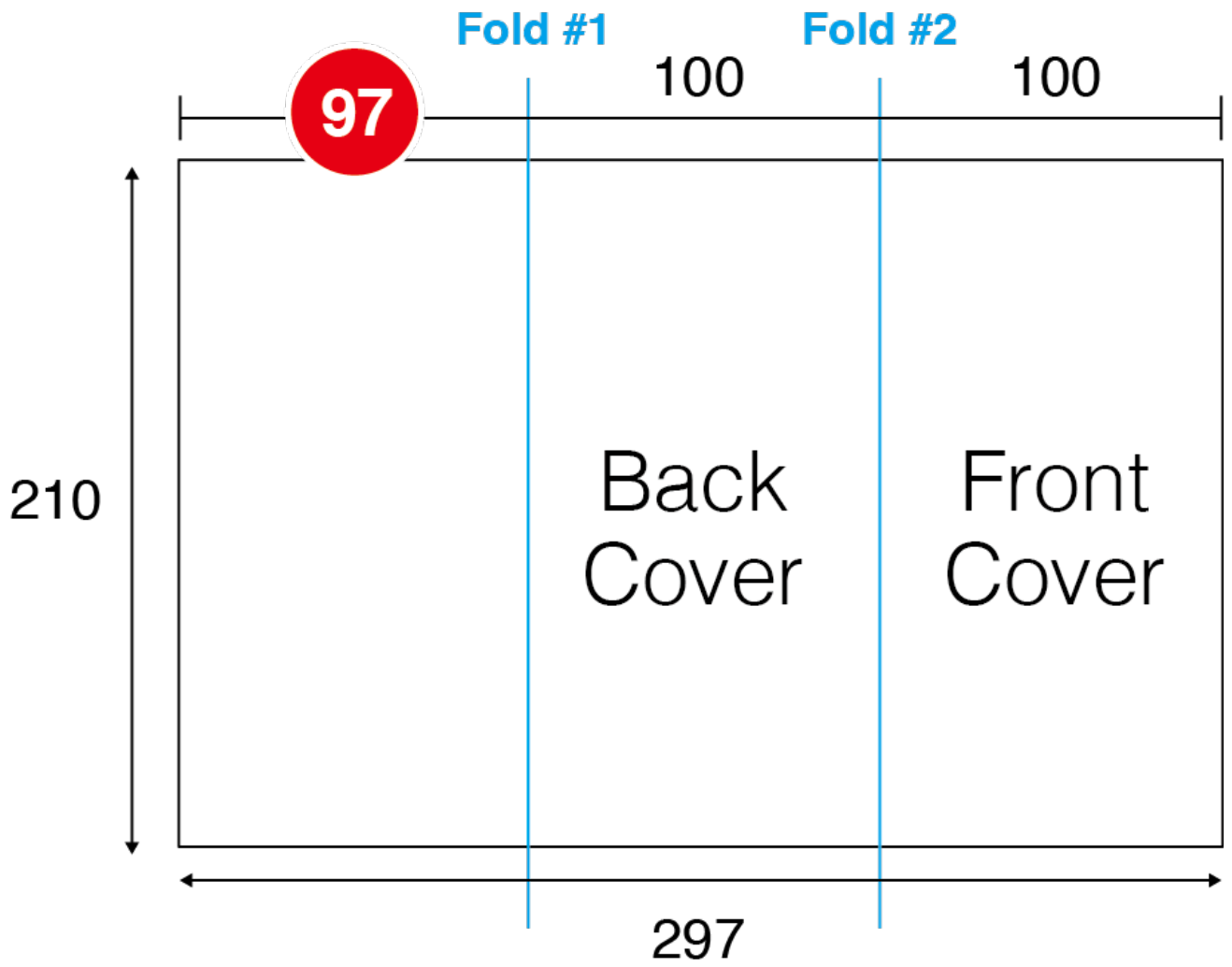

BOTTOM

Inside

TOP

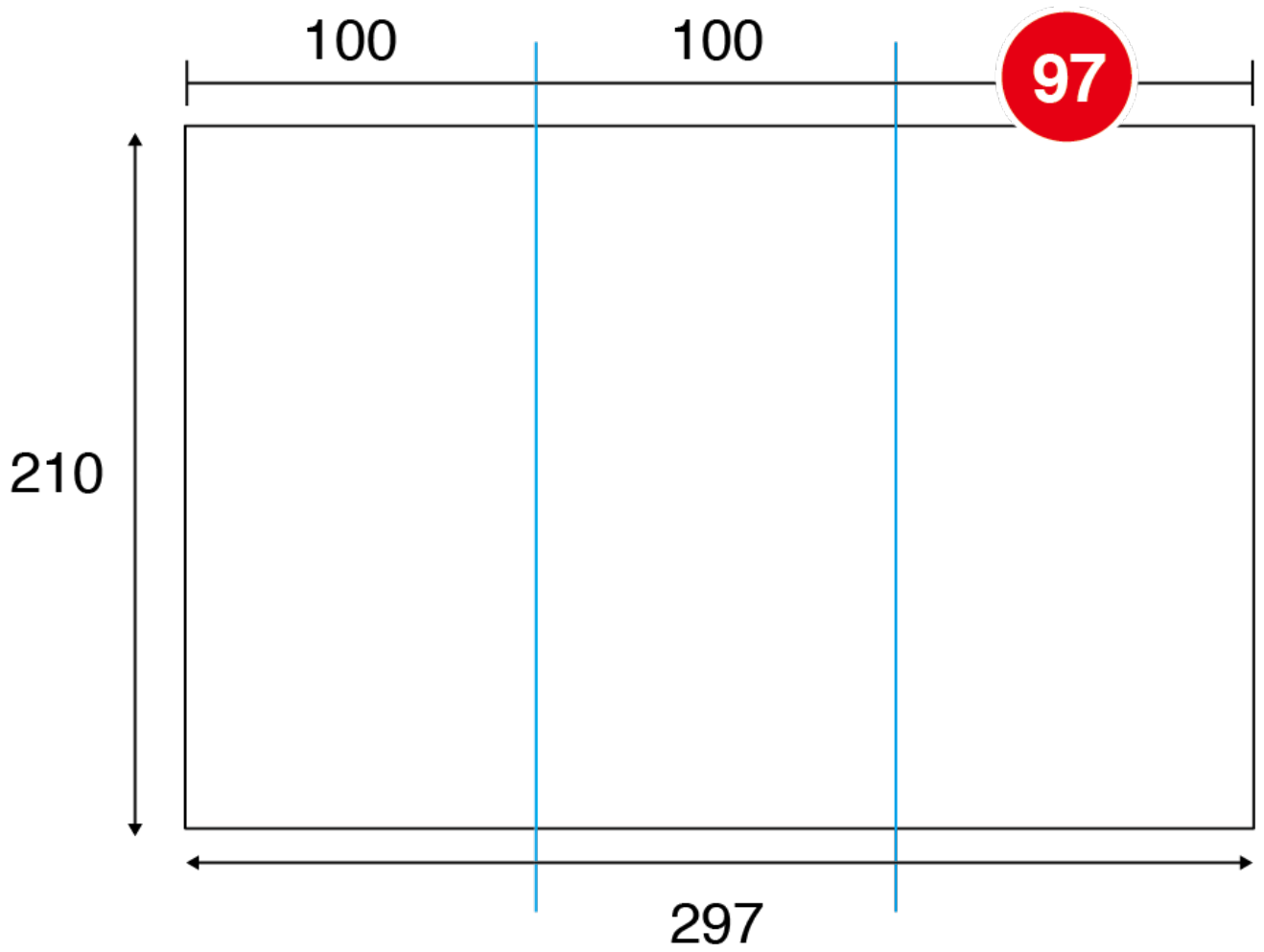

BOTTOM

After Folding



100

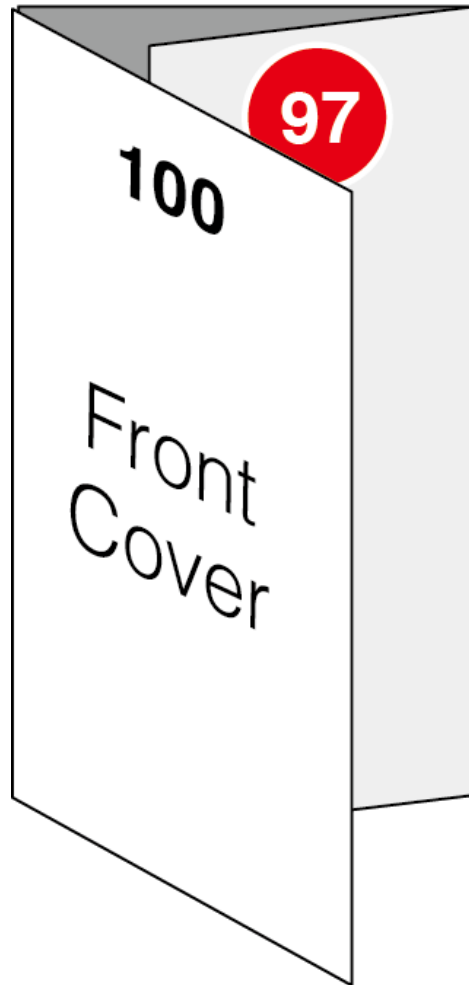

For us to trifold your data correctly, you need to label the following:

- 1) Which will be the Outside Front panel and the Outside Back panel.
- 2) Where does it need to fold? Mark the folding line with a guide.

Z-fold, or zig-zag fold

A Z-fold is created by folding a paper back and forth, to create a 'Z' shape (if seen from above). Because there is no inner folding panel (compared to a trifold), the panels can be the same width. The Z-fold brochure contains two parallel folds, each folding in opposite directions like an accordion.

Z-fold pamphlets most commonly open from left to right, though it's not unusual to have them open from right to left when designing for Middle Eastern or Asian languages. Z-fold brochures make great step-by-step information guide, and can also be used for designs that take up the entire width of the document when opened.

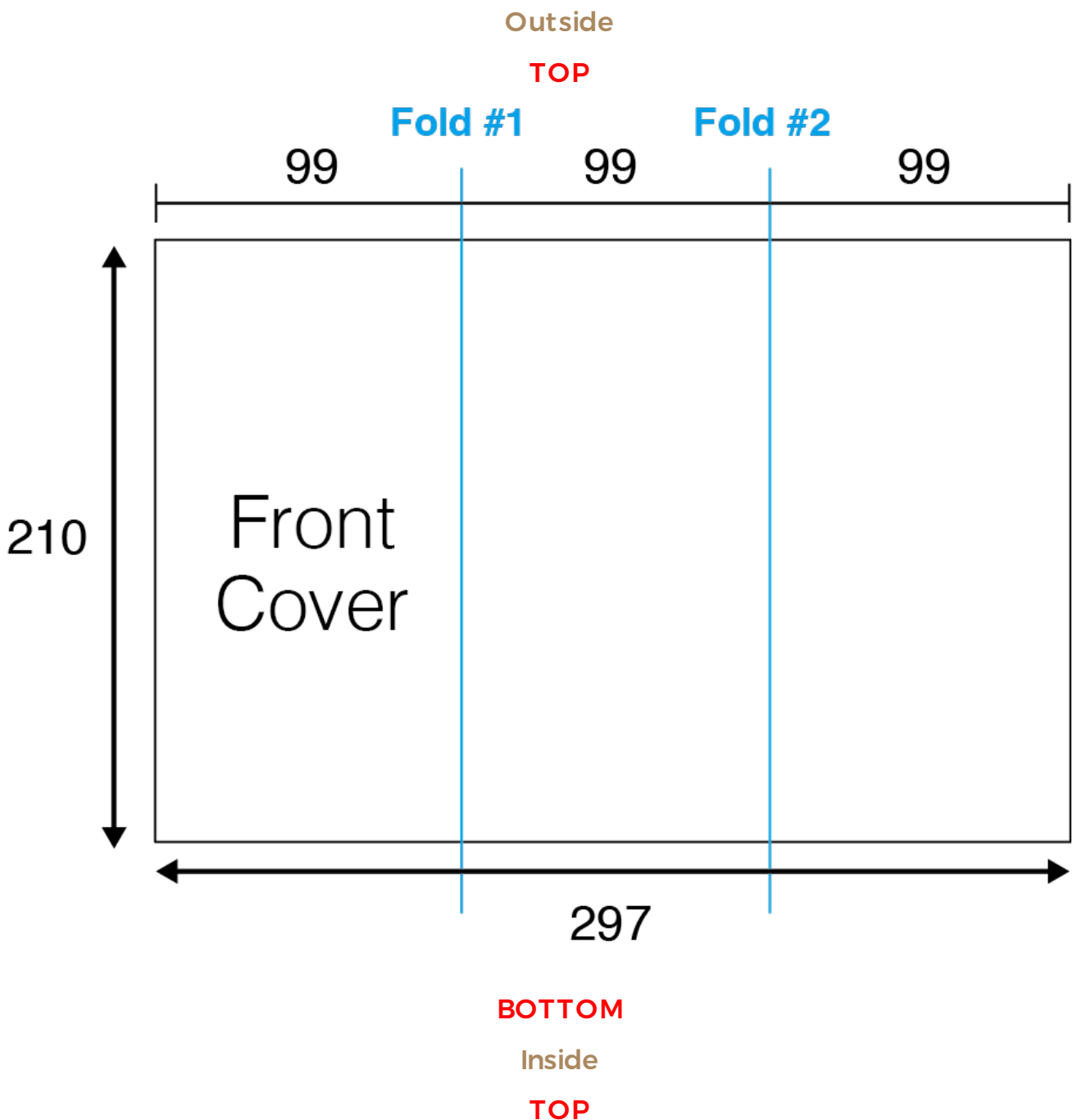

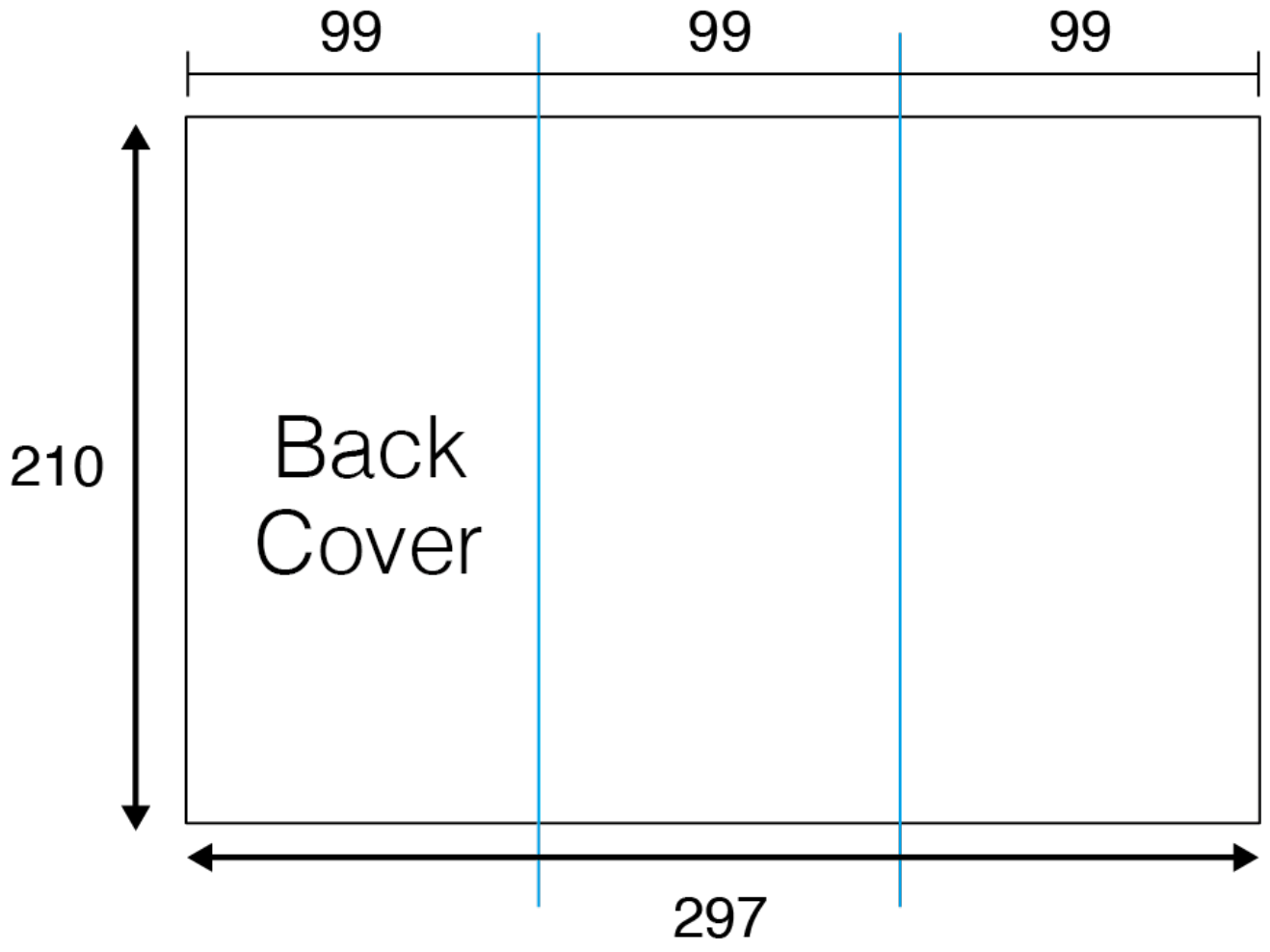

BOTTOM

After Folding



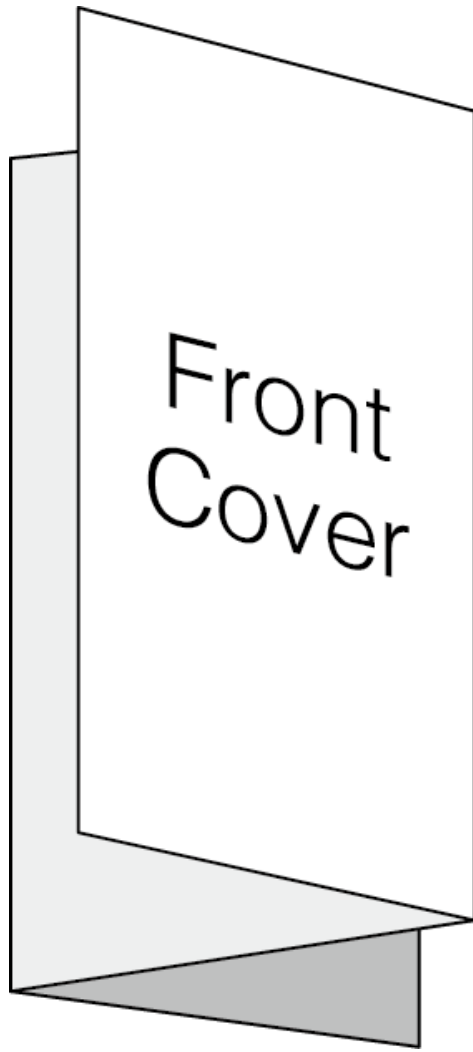

Outside

TOP

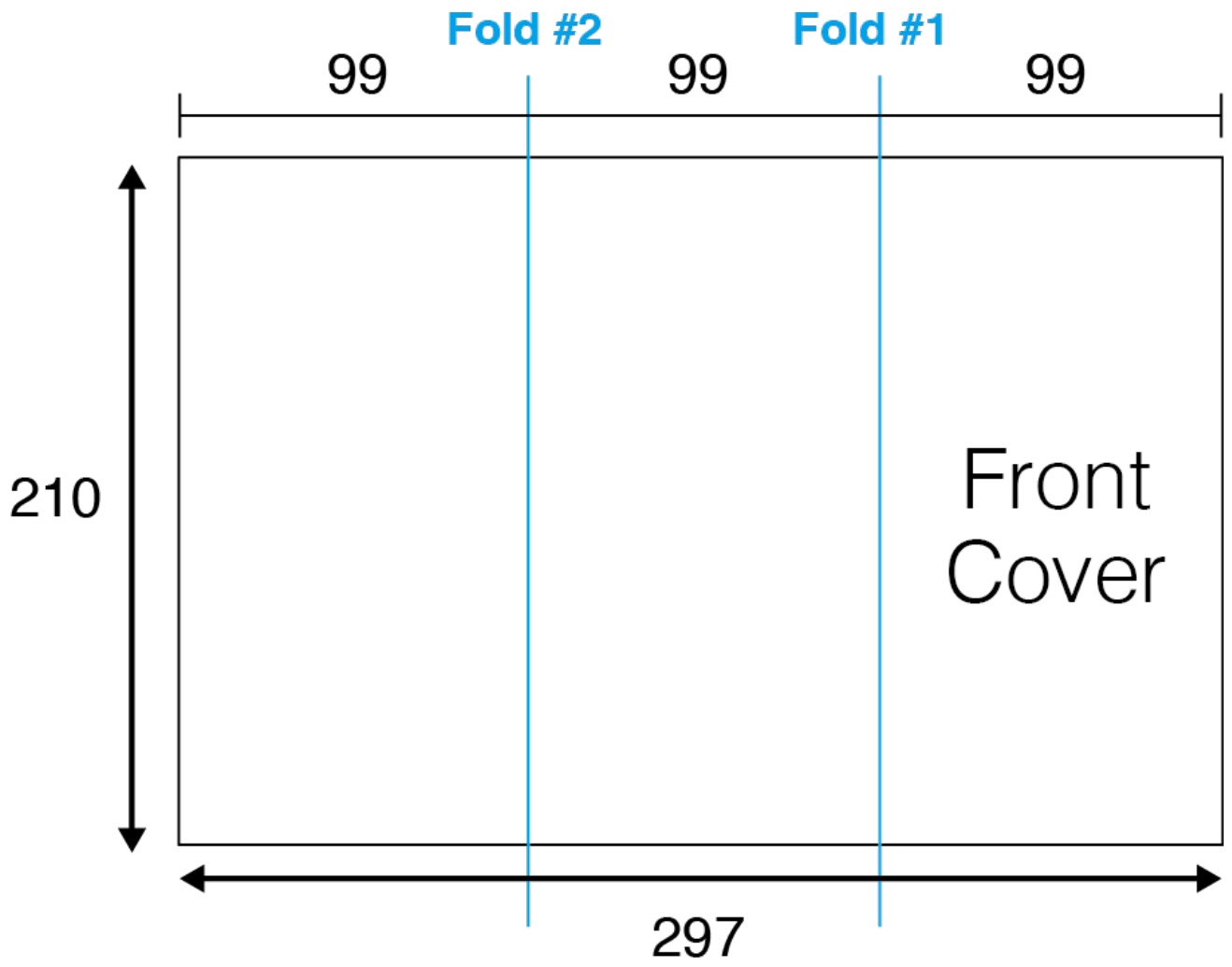

BOTTOM

Inside

TOP

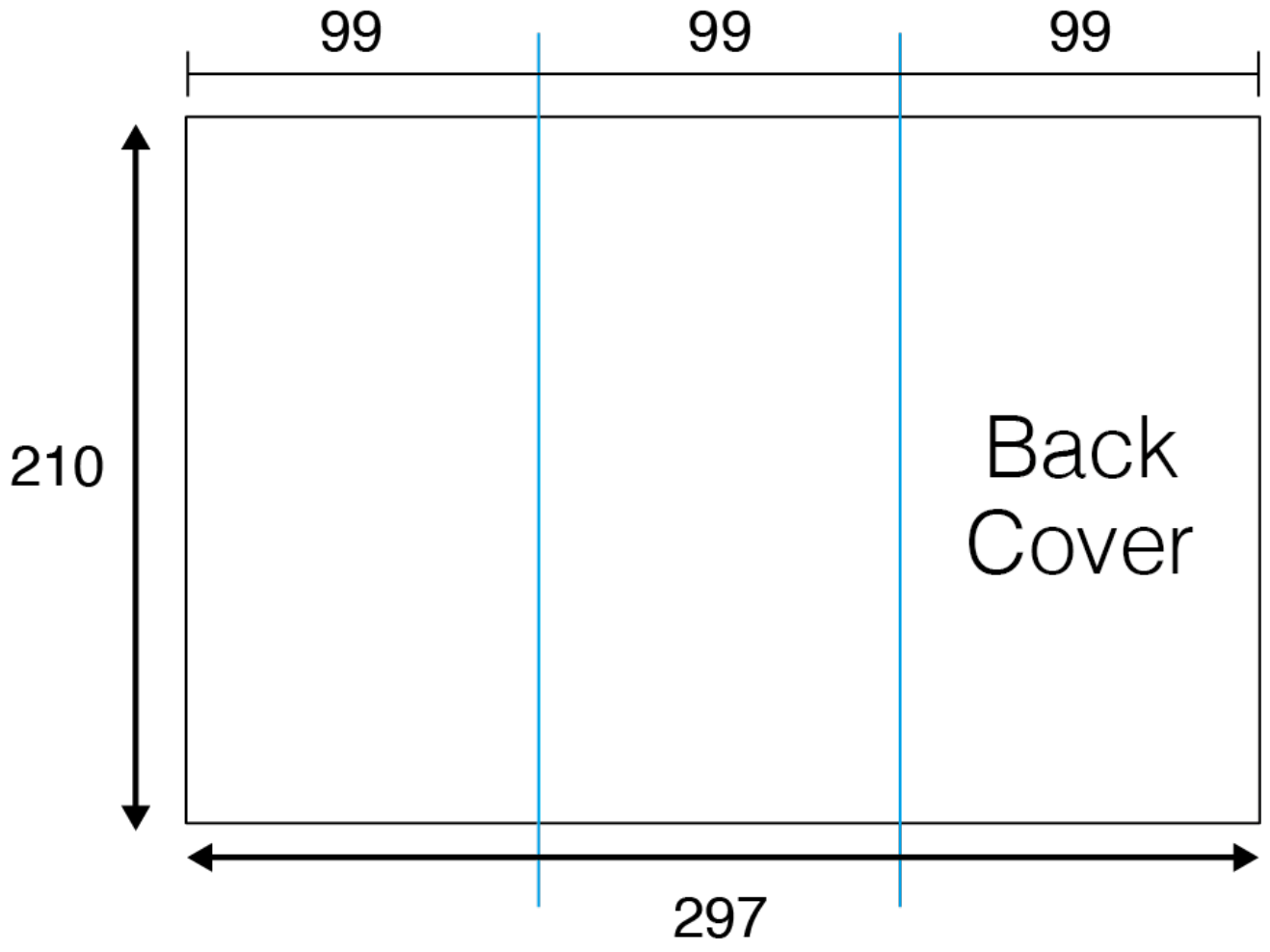

BOTTOM

After Folding



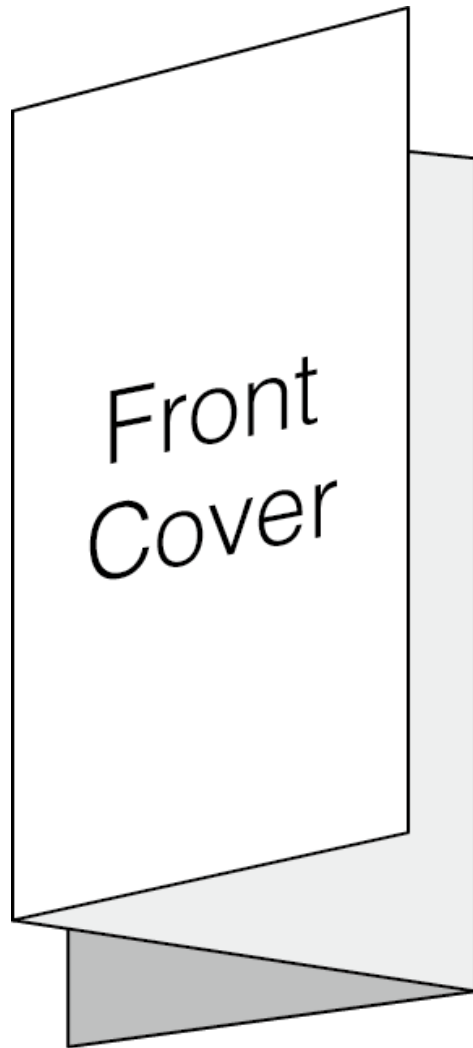

For us to Z-fold your data correctly, you need to label the following:

- 1) Which will be the Outside Front panel and the Outside Back panel.
- 2) Where does it need to fold? Mark the folding line with a guide.
- 3) The direction of the fold. Will it be a Mountain Fold (\wedge) or a Valley Fold (V)?

Folding Guidelines

There are many ways to fold printed pieces of paper. The way they fold and unfold can be an essential factor to the presentation of your layout or design. Below are a list of standard paper sizes and folding pitch measurements should you want to create custom sized folded brochures.

Half folds

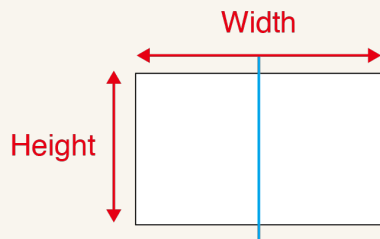

Open Size

Width Height

A6	148	100
B6	182	128
A5	210	148
CD x 2	240	120
B5	257	182
A4	297	210
B4	364	257
A3	420	297

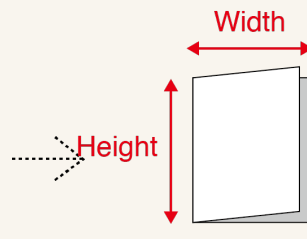

Final Size

Width Height

A7	74	100
B7	91	128
A6	105	148
CD	120	120
B6	128.5	182
A5	148.5	210
B5	182	257
A4	210	297

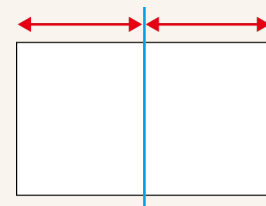

Panels

Width

74 · 74
91 · 91
105 · 105
120 · 120
128.5 · 128.5
148.5 · 148.5
182 · 182
210 · 210

Trifolds

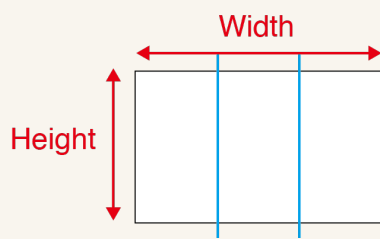

Open Size

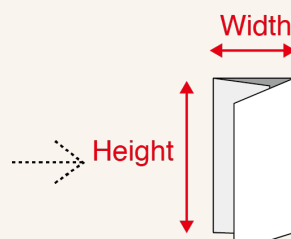

Final Size

Width Height

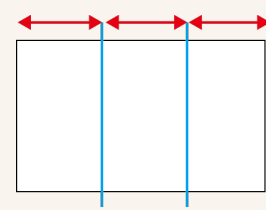

Panels

Width Height

A5	148	210
B5	182	257
A4	210	297
CD x 3	120	357
A5 x 3	210	441
B4	257	364
A3	297	420
A4 x 3	297	627

Width Height

	71	148
	87	182
	100	210
CD	120	120
A5	148	210
	122.5	257
	141	297
A4	210	297

Width

71 · 71 · 68
87 · 87 · 83
100 · 100 · 97
120 · 120 · 117
148 · 148 · 145
122.5 · 122.5 · 119
141 · 141 · 138
210 · 210 · 207

Z-folds

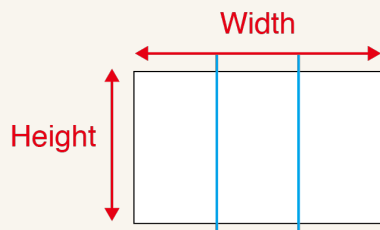

Open Size

Width Height

A5	148	210
B5	182	257
A4	210	297
CD x 3	120	357
A5 x 3	210	441
B4	257	364
A3	297	420
A4 x 3	297	627

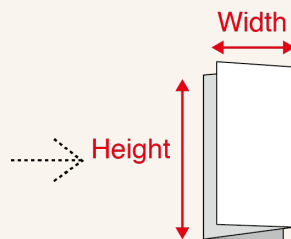

Final Size

Width Height

	71	148
	85.7	182
	99	210
CD	119	120
A5	147	210
	121.4	257
	140	297
A4	209	297

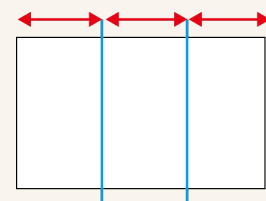

Panels

Width

70 · 70 · 70
85.6 · 85.7 · 85.7
99 · 99 · 99
119 · 119 · 119
147 · 147 · 147
121.3 · 121.3 · 121.4
140 · 140 · 140
209 · 209 · 209



Note: When submitting data to be folded, your artwork should be setup up to the open size. For example, if you want to print an Z-fold A4 brochure, don't

send us 6 99x210mm files. Download our free layout templates to set your design up. Otherwise we may have to charge you additional artworking fees to set up the data up for you.